

Features

- Fast Read Access Time - 150 ns
- Fast Byte Write - 200 μ s or 1 ms
- Self-Timed Byte Write Cycle
 - Internal Address and Data Latches
 - Internal Control Timer
 - Automatic Clear Before Write
- Direct Microprocessor Control
 - DATA POLLING
- Low Power
 - 30 mA Active Current
 - 100 μ A CMOS Standby Current
- High Reliability
 - Endurance: 10^4 or 10^5 Cycles
 - Data Retention: 10 Years
- 5V \pm 10% Supply
- CMOS & TTL Compatible Inputs and Outputs
- JEDEC Approved Byte Wide Pinout
- Commercial and Industrial Temperature Ranges

Description

The AT28C16 is a low-power, high-performance Electrically Erasable and Programmable Read Only Memory with easy to use features. The AT28C16 is a 16K memory organized as 2,048 words by 8 bits. The device is manufactured with Atmel's reliable nonvolatile CMOS technology.

(continued)

Pin Configurations

Pin Name	Function
A0 - A10	Addresses
\overline{CE}	Chip Enable
\overline{OE}	Output Enable
\overline{WE}	Write Enable
I/O0 - I/O7	Data Inputs/Outputs
NC	No Connect
DC	Don't Connect

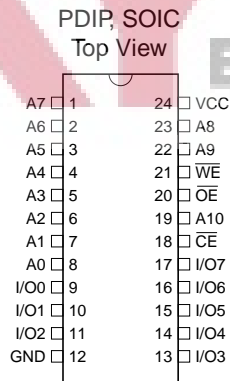
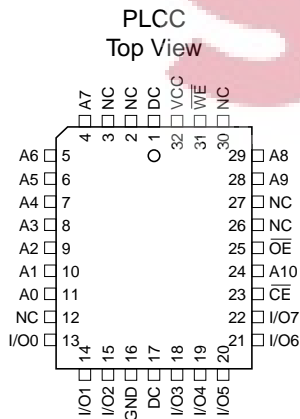

Note: PLCC package pins 1 and 17 are DON'T CONNECT.



16K (2K x 8)
Parallel
EEPROMs

AT28C16

Rev. 0540B-10/98



The AT28C16 is accessed like a static RAM for the read or write cycles without the need of external components. During a byte write, the address and data are latched internally, freeing the microprocessor address and data bus for other operations. Following the initiation of a write cycle, the device will go to a busy state and automatically clear and write the latched data using an internal control timer. The end of a write cycle can be determined by $\overline{\text{DATA POLLING}}$ of I/O₇. Once the end of a write cycle has been detected, a new access for a read or a write can begin.

The CMOS technology offers fast access times of 150 ns at low power dissipation. When the chip is deselected the standby current is less than 100 μA .

Atmel's 28C16 has additional features to ensure high quality and manufacturability. The device utilizes error correction internally for extended endurance and for improved data retention characteristics. An extra 32 bytes of EEPROM are available for device identification or tracking.

Block Diagram

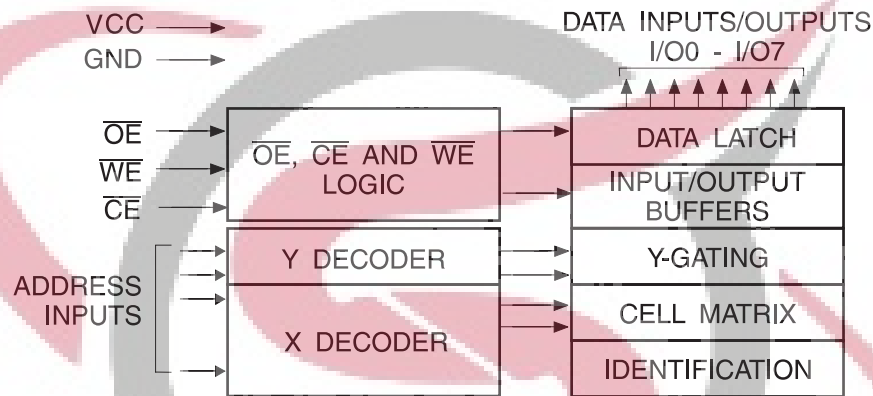

Absolute Maximum Ratings*

Temperature Under Bias	-55°C to +125°C
Storage Temperature	-65°C to +150°C
All Input Voltages (including NC Pins) with Respect to Ground	-0.6V to +6.25V
All Output Voltages with Respect to Ground	-0.6V to $V_{\text{CC}} + 0.6\text{V}$
Voltage on $\overline{\text{OE}}$ and A9 with Respect to Ground	-0.6V to +13.5V

***NOTICE:** Stresses beyond those listed under "Absolute Maximum Ratings" may cause permanent damage to the device. This is a stress rating only and functional operation of the device at these or any other conditions beyond those indicated in the operational sections of this specification is not implied. Exposure to absolute maximum rating conditions for extended periods may affect device reliability

Device Operation

READ: The AT28C16 is accessed like a Static RAM. When \overline{CE} and \overline{OE} are low and \overline{WE} is high, the data stored at the memory location determined by the address pins is asserted on the outputs. The outputs are put in a high impedance state whenever \overline{CE} or \overline{OE} is high. This dual line control gives designers increased flexibility in preventing bus contention.

BYTE WRITE: Writing data into the AT28C16 is similar to writing into a Static RAM. A low pulse on the \overline{WE} or \overline{CE} input with \overline{OE} high and \overline{CE} or \overline{WE} low (respectively) initiates a byte write. The address location is latched on the last falling edge of \overline{WE} (or \overline{CE}); the new data is latched on the first rising edge. Internally, the device performs a self-clear before write. Once a byte write has been started, it will automatically time itself to completion. Once a programming operation has been initiated and for the duration of t_{WC} , a read operation will effectively be a polling operation.

FAST BYTE WRITE: The AT28C16E offers a byte write time of 200 μ s maximum. This feature allows the entire device to be rewritten in 0.4 seconds.

DATA POLLING: The AT28C16 provides \overline{DATA} POLLING to signal the completion of a write cycle. During a write

cycle, an attempted read of the data being written results in the complement of that data for I/O₇ (the other outputs are indeterminate). When the write cycle is finished, true data appears on all outputs.

WRITE PROTECTION: Inadvertent writes to the device are protected against in the following ways: (a) V_{CC} sense—if V_{CC} is below 3.8V (typical) the write function is inhibited; (b) V_{CC} power on delay—once V_{CC} has reached 3.8V the device will automatically time out 5 ms (typical) before allowing a byte write; and (c) write inhibit—holding any one of \overline{OE} low, \overline{CE} high or \overline{WE} high inhibits byte write cycles.

CHIP CLEAR: The contents of the entire memory of the AT28C16 may be set to the high state by the CHIP CLEAR operation. By setting \overline{CE} low and \overline{OE} to 12 volts, the chip is cleared when a 10 msec low pulse is applied to \overline{WE} .

DEVICE IDENTIFICATION: An extra 32 bytes of EEPROM memory are available to the user for device identification. By raising A9 to $12 \pm 0.5V$ and using address locations 7E0H to 7FFH the additional bytes may be written to or read from in the same manner as the regular memory array.

SKYTECH
ELECTRONIC

DC and AC Operating Range

		AT28C16-15
Operating Temperature (Case)	Com.	0°C - 70°C
	Ind.	-40°C - 85°C
V _{CC} Power Supply		5V ± 10%

Operating Modes

Mode	\overline{CE}	\overline{OE}	\overline{WE}	I/O
Read	V _{IL}	V _{IL}	V _{IH}	D _{OUT}
Write ⁽²⁾	V _{IL}	V _{IH}	V _{IL}	D _{IN}
Standby/Write Inhibit	V _{IH}	X ⁽¹⁾	X	High Z
Write Inhibit	X	X	V _{IH}	
Write Inhibit	X	V _{IL}	X	
Output Disable	X	V _{IH}	X	High Z
Chip Erase	V _{IL}	V _H ⁽³⁾	V _{IL}	High Z

- Notes: 1. X can be V_{IL} or V_{IH}.
 2. Refer to AC Programming Waveforms.
 3. V_H = 12.0V ± 0.5V

DC Characteristics

Symbol	Parameter	Condition	Min	Max	Units
I _{LI}	Input Load Current	V _{IN} = 0V to V _{CC} + 1V		10	μA
I _{LO}	Output Leakage Current	V _{I/O} = 0V to V _{CC}		10	μA
I _{SB1}	V _{CC} Standby Current CMOS	$\overline{CE} = V_{CC} - 0.3V$ to V _{CC} + 1.0V		100	μA
I _{SB2}	V _{CC} Standby Current TTL	$\overline{CE} = 2.0V$ to V _{CC} + 1.0V	Com.	2	mA
			Ind.	3	mA
I _{CC}	V _{CC} Active Current AC	f = 5 MHz; I _{OUT} = 0 mA $\overline{CE} = V_{IL}$	Com.	30	mA
			Ind.	45	mA
V _{IL}	Input Low Voltage			0.8	V
V _{IH}	Input High Voltage		2.0		V
V _{OL}	Output Low Voltage	I _{OL} = 2.1 mA		.4	V
V _{OH}	Output High Voltage	I _{OH} = -400 μA	2.4		V

AC Read Characteristics

Symbol	Parameter	AT28C16-15		Units
		Min	Max	
t_{ACC}	Address to Output Delay		150	ns
$t_{CE}^{(1)}$	\overline{CE} to Output Delay		150	ns
$t_{OE}^{(2)}$	\overline{OE} to Output Delay	10	70	ns
$t_{DF}^{(3)(4)}$	\overline{CE} or \overline{OE} High to Output Float	0	50	ns
t_{OH}	Output Hold from \overline{OE} , \overline{CE} or Address, whichever occurred first	0		ns

AC Read Waveforms⁽¹⁾⁽²⁾⁽³⁾⁽⁴⁾

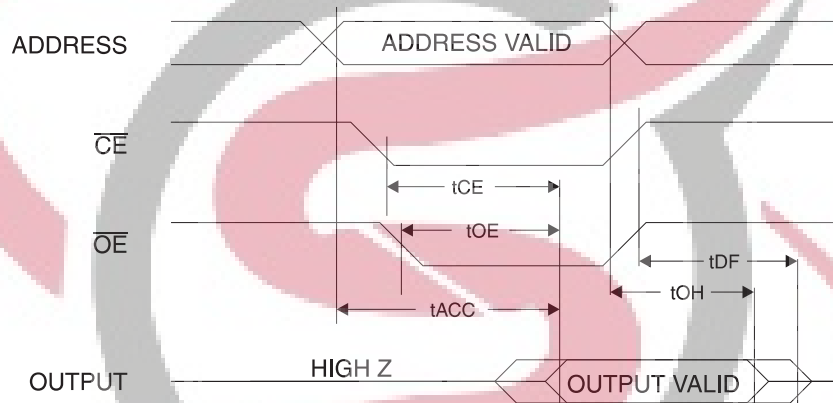

- Notes:
- \overline{CE} may be delayed up to $t_{ACC} - t_{CE}$ after the address transition without impact on t_{ACC} .
 - \overline{OE} may be delayed up to $t_{CE} - t_{OE}$ after the falling edge of \overline{CE} without impact on t_{CE} or by $t_{ACC} - t_{OE}$ after an address change without impact on t_{ACC} .
 - t_{DF} is specified from \overline{OE} or \overline{CE} whichever occurs first ($C_L = 5$ pF).
 - This parameter is characterized and is not 100% tested.

Input Test Waveforms and Measurement Level

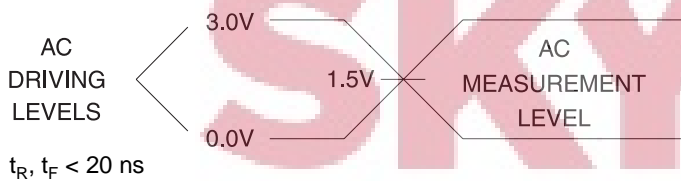

Output Test Load

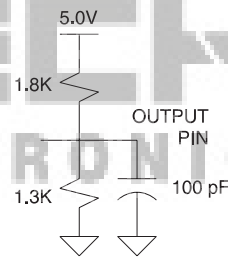

Pin Capacitance

$f = 1$ MHz, $T = 25^\circ\text{C}^{(1)}$

Symbol	Typ	Max	Units	Conditions
C_{IN}	4	6	pF	$V_{IN} = 0V$
C_{OUT}	8	12	pF	$V_{OUT} = 0V$

- Note: 1. This parameter is characterized and is not 100% tested.

AC Write Characteristics

Symbol	Parameter	Min	Typ	Max	Units
t_{AS}, t_{OES}	Address, \overline{OE} Set-up Time	10			ns
t_{AH}	Address Hold Time	50			ns
t_{WP}	Write Pulse Width (\overline{WE} or \overline{CE})	100		1000	ns
t_{DS}	Data Set-up Time	50			ns
t_{DH}, t_{OEH}	Data, \overline{OE} Hold Time	10			ns
t_{CS}, t_{CH}	\overline{CE} to \overline{WE} and \overline{WE} to \overline{CE} Set-up and Hold Time	0			ns
t_{WC}	Write Cycle Time	AT28C16	0.5	1.0	ms
		AT28C16E	100	200	μ s

AC Write Waveforms

\overline{WE} Controlled

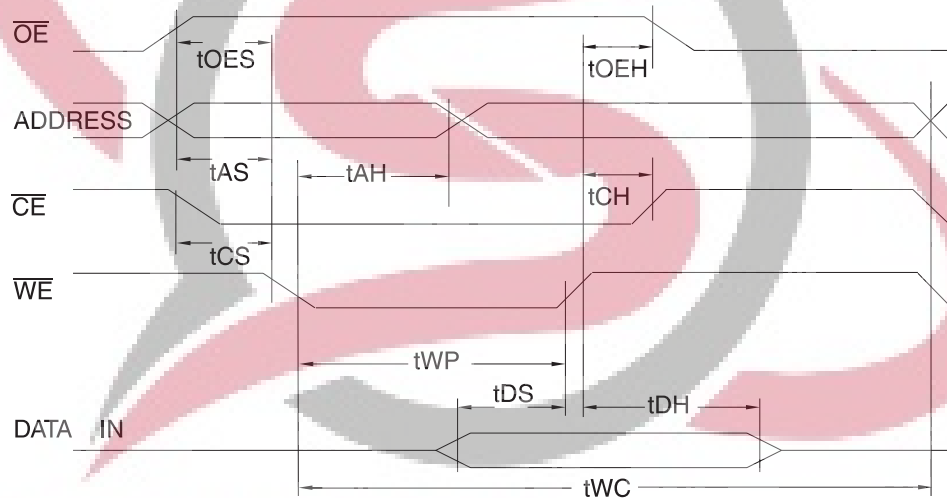

\overline{CE} Controlled

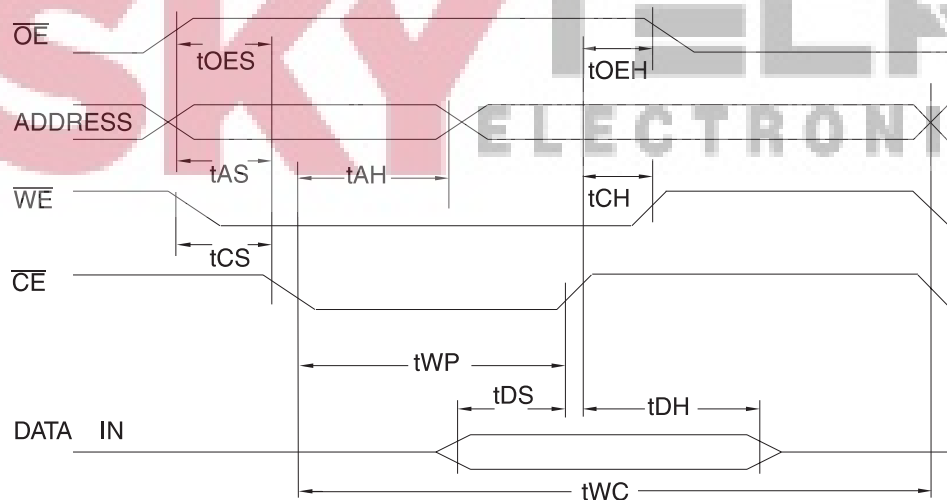

Data Polling Characteristics⁽¹⁾

Symbol	Parameter	Min	Typ	Max	Units
t_{DH}	Data Hold Time	10			ns
$t_{OE H}$	\overline{OE} Hold Time	10			ns
t_{OE}	\overline{OE} to Output Delay ⁽²⁾				ns
t_{WR}	Write Recovery Time	0			ns

Notes: 1. These parameters are characterized and not 100% tested.
 2. See AC Characteristics.

Data Polling Waveforms

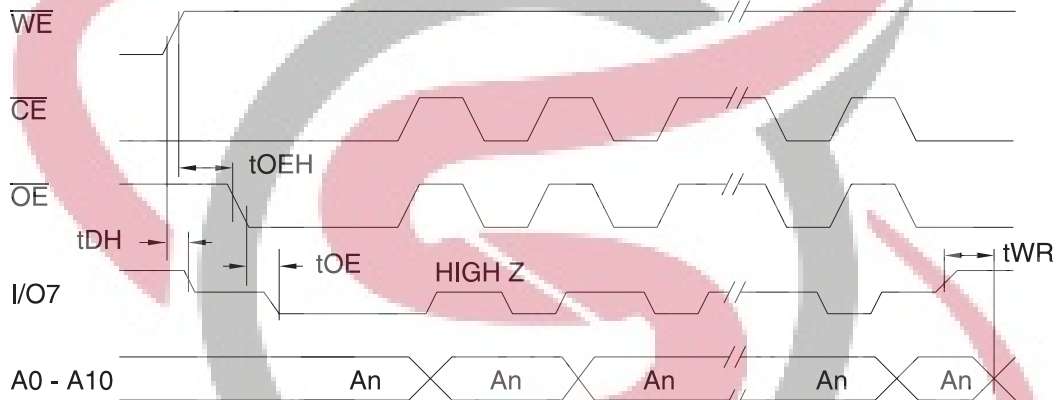

Chip Erase Waveforms

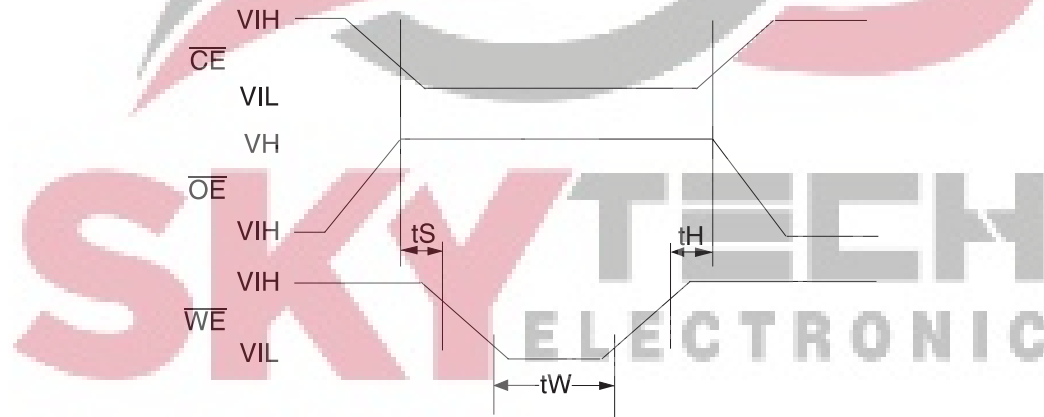

$t_S = t_H = 1 \mu\text{sec (min.)}$
 $t_W = 10 \text{ msec (min.)}$
 $V_H = 12.0V \pm 0.5V$

NORMALIZED SUPPLY CURRENT vs. TEMPERATURE

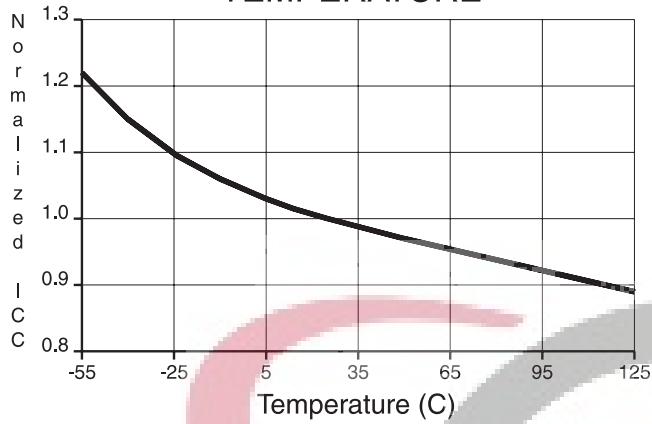

NORMALIZED SUPPLY CURRENT vs. SUPPLY VOLTAGE

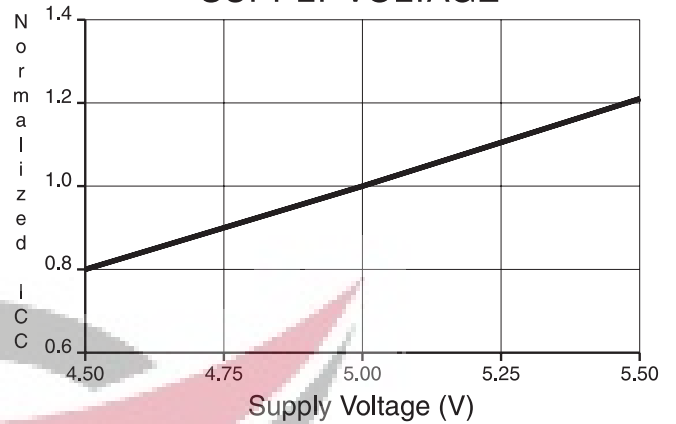

NORMALIZED SUPPLY CURRENT vs. ADDRESS FREQUENCY

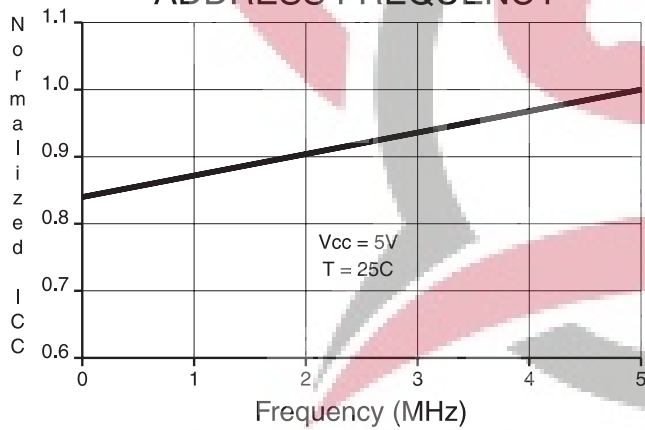

NORMALIZED ACCESS TIME vs. OUTPUT LOAD

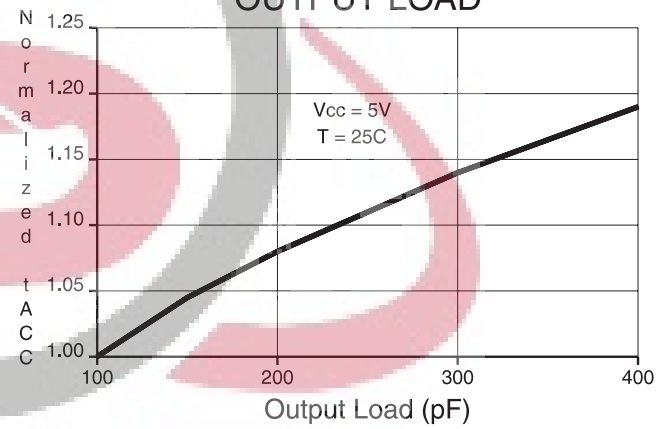

OUTPUT SINK CURRENT vs. OUTPUT VOLTAGE

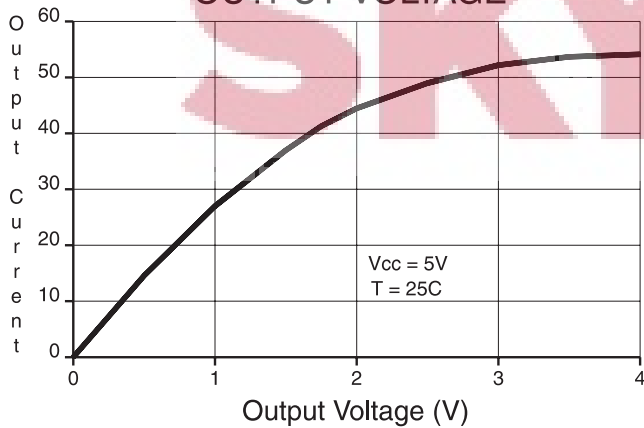

OUTPUT SOURCE CURRENT vs. OUTPUT VOLTAGE

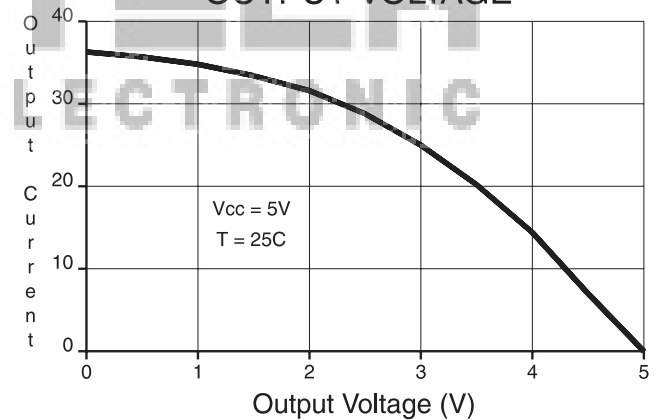

Ordering Information⁽¹⁾

t _{ACC} (ns)	I _{CC} (mA)		Ordering Code	Package	Operation Range
	Active	Standby			
150	30	0.1	AT28C16(E)-15JC AT28C16(E)-15PC AT28C16(E)-15SC	32J 24P6 24S	Commercial (0°C to 70°C)
	45	0.1	AT28C16(E)-15JI AT28C16(E)-15PI AT28C16(E)-15SI	32J 24P6 24S	Industrial (-40°C to 85°C)

- Notes:
1. See Valid Part Numbers table below.
 2. The 28C16 200 ns and 250 ns speed selections have been removed from valid selections table and are replaced by the faster 150 ns T_{AA} offering.
 3. The 28C16 ceramic package offerings have been removed. New designs should utilize the 28C256 ceramic offerings.

Valid Part Numbers

The following table lists standard Atmel products that can be ordered.

Device Numbers	Speed	Package and Temperature Combinations
AT28C16	15	JC, JI, PC, PI, SC, SI
AT28C16E	15	JC, JI, PC, PI, SC, SI
AT28C16	-	W

Die Products

Reference Section: Parallel EEPROM Die Products

SKYTECH
ELECTRONIC

Package Type	
32J	32 Lead, Plastic J-Leaded Chip Carrier (PLCC)
24P6	24 Lead, 0.600" Wide, Plastic Dual Inline Package (PDIP)
24S	24 Lead, 0.300" Wide, Plastic Gull Wing Small Outline (SOIC)
W	Die
Options	
Blank	Standard Device: Endurance = 10K Write Cycles; Write Time = 1 ms
E	High Endurance Option: Endurance = 100K Write Cycles; Write Time = 200 μs

Packaging Information

32J, 32-Lead, Plastic J-Leaded Chip Carrier (PLCC)
 Dimensions in Inches and (Millimeters)
 JEDEC STANDARD MS-018 AA

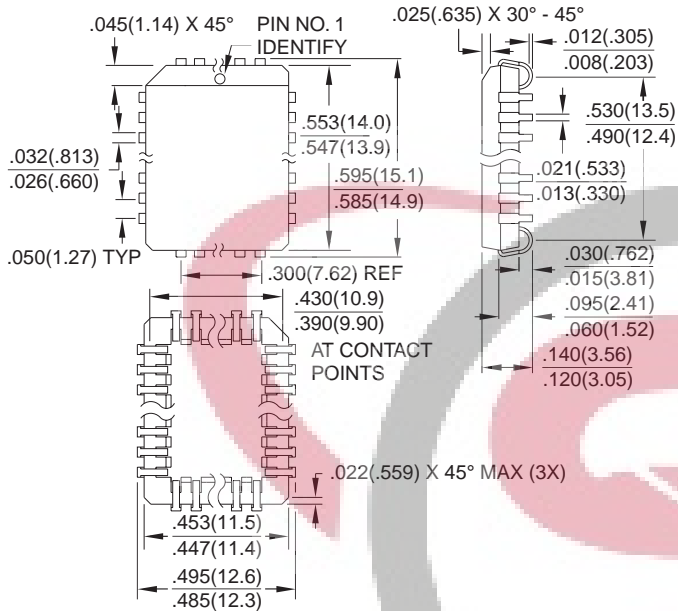

24P6, 24-Lead, 0.600" Wide, Plastic Dual Inline Package (PDIP)
 Dimensions in Inches and (Millimeters)
 JEDEC STANDARD MS-011 AA

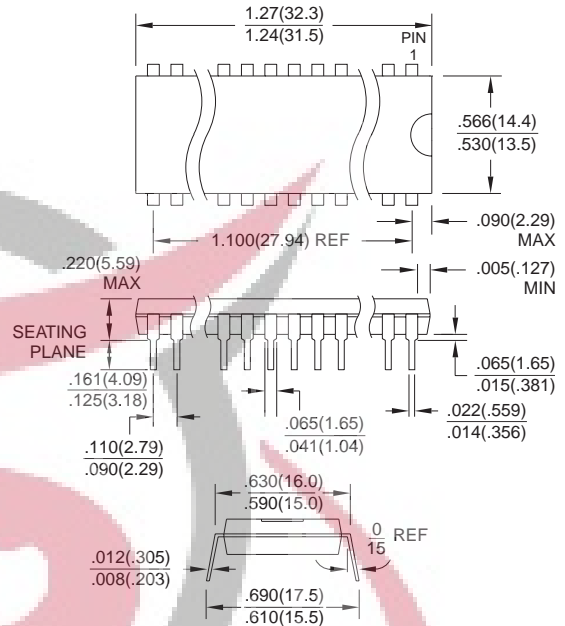

24S, 24-Lead, 0.300" Wide, Plastic Gull Wing Small Outline (SOIC)
 Dimensions in Inches and (Millimeters)

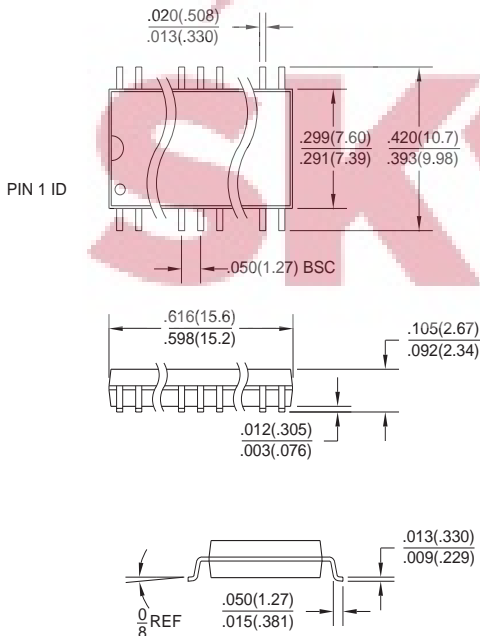





Atmel Headquarters

Corporate Headquarters
2325 Orchard Parkway
San Jose, CA 95131
TEL (408) 441-0311
FAX (408) 487-2600

Europe

Atmel U.K., Ltd.
Coliseum Business Centre
Riverside Way
Camberley, Surrey GU15 3YL
England
TEL (44) 1276-686677
FAX (44) 1276-686697

Asia

Atmel Asia, Ltd.
Room 1219
Chinachem Golden Plaza
77 Mody Road
Tsimshatsui East
Kowloon, Hong Kong
TEL (852) 27219778
FAX (852) 27221369

Japan

Atmel Japan K.K.
Tonetsu Shinkawa Bldg., 9F
1-24-8 Shinkawa
Chuo-ku, Tokyo 104-0033
Japan
TEL (81) 3-3523-3551
FAX (81) 3-3523-7581

Atmel Operations

Atmel Colorado Springs
1150 E. Cheyenne Mtn. Blvd.
Colorado Springs, CO 80906
TEL (719) 576-3300
FAX (719) 540-1759

Atmel Rousset

Zone Industrielle
13106 Rousset Cedex, France
TEL (33) 4 42 53 60 00
FAX (33) 4 42 53 60 01



Fax-on-Demand

North America:
1-(800) 292-8635
International:
1-(408) 441-0732

e-mail
literature@atmel.com

Web Site
<http://www.atmel.com>

BBS
1-(408) 436-4309

© Atmel Corporation 1998.

Atmel Corporation makes no warranty for the use of its products, other than those expressly contained in the Company's standard warranty which is detailed in Atmel's Terms and Conditions located on the Company's website. The Company assumes no responsibility for any errors which may appear in this document, reserves the right to change devices or specifications detailed herein at any time without notice, and does not make any commitment to update the information contained herein. No licenses to patents or other intellectual property of Atmel are granted by the Company in connection with the sale of Atmel products, expressly or by implication. Atmel's products are not authorized for use as critical components in life support devices or systems.

Marks bearing ® and/or ™ are registered trademarks and trademarks of Atmel Corporation.

Terms and product names in this document may be trademarks of others.



Printed on recycled paper.

0540B-10/98/xM